

 **SENNHEISER**



**SKP 2000**

Instruction manual

# Contents

Important safety instructions .....	2
The SKP 2000 plug-on transmitter .....	3
Areas of application .....	3
The frequency bank system .....	4
Delivery includes .....	5
Product overview .....	6
Overview of the SKP 2000 plug-on transmitter .....	6
Overview of the displays .....	7
Putting the plug-on transmitter into operation .....	8
Inserting the batteries/accupack .....	8
Charging the accupack .....	9
Plugging the plug-on transmitter onto a microphone .....	9
Using the plug-on transmitter .....	10
Switching the plug-on transmitter on/off .....	10
Deactivating the lock mode temporarily .....	11
Muting the audio signal or deactivating the RF signal .....	12
Selecting a standard display .....	14
Using the operating menu .....	15
The buttons .....	15
Overview of the operating menu .....	15
Working with the operating menu .....	17
Adjusting settings via the operating menu .....	19
The main menu "Menu" .....	19
The extended menu "Advanced Menu" .....	22
Synchronizing the plug-on transmitter with a receiver .....	26
Cleaning the plug-on transmitter .....	27
Recommendations and tips .....	28
If a problem occurs ... ..	29
Accessories .....	30
Specifications .....	31
Manufacturer Declarations .....	33
Index .....	35



Supplementary information can be found on the SKP 2000 product page on our website at [www.sennheiser.com](http://www.sennheiser.com).

## Important safety instructions

- Read this instruction manual.
- Keep this instruction manual. Always include this instruction manual when passing the product on to third parties.
- Heed all warnings and follow all instructions in this instruction manual.
- Use only a cloth for cleaning the product.
- Do not place the product near any heat sources such as radiators, stoves, or other devices (including amplifiers) that produce heat.
- Only use attachments/accessories specified by Sennheiser.
- Refer all servicing to qualified service personnel.  
Servicing is required if the product has been damaged in any way, liquid has been spilled, objects have fallen inside, the product has been exposed to rain or moisture, does not operate properly or has been dropped.
- **WARNING:** To reduce the risk of short circuits, do not use the product near water and do not expose it to rain or moisture.

### Replacement parts

When replacement parts are required, be sure the service technician uses replacement parts specified by Sennheiser or those having the same characteristics as the original part. Unauthorized substitutions may result in fire, electric shock, or other hazards.

### Intended use

Intended use of the SKP 2000 plug-on transmitter includes:

- having read these instructions especially the chapter “Important safety instructions”,
- using the product within the operating conditions and limitations described in this instruction manual.

“Improper use” means using the product other than as described in this instruction manual, or under operating conditions which differ from those described herein.

## The SKP 2000 plug-on transmitter

This plug-on transmitter is part of the 2000 series. With this series, Sennheiser offers high-quality state-of-the-art RF transmission systems with a high level of operational reliability and ease of use. Transmitters and receivers permit wireless transmission with studio-quality sound.



Features of the 2000 series:

- Optimized PLL synthesizer and microprocessor technology
- HDX noise reduction system
- Pilot tone squelch control
- Switching bandwidth of up to 75 MHz
- Increased immunity to intermodulation and interferences in multi-channel operation

### Areas of application

The plug-on transmitter can be combined with the EK 2000 portable receiver and the EM 2000 and EM 2050 rack-mount receivers. These receivers are available in the same UHF frequency ranges and are equipped with the same frequency bank system. This has the advantage that

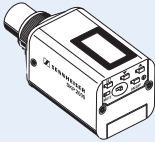
- a transmission system is ready for immediate use after switch-on,
- several transmission systems can be operated simultaneously on the preset frequencies without causing intermodulation interference.

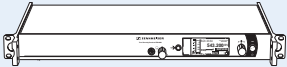
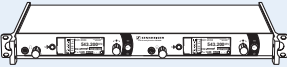
Transmitter	Combinable with ...	Receiver
SKP 2000 	dynamic and condenser microphones  We recommend using Sennheiser microphones.	EK 2000 portable receiver   EM 2000 receiver   EM 2050 twin receiver 

## The frequency bank system

The plug-on transmitter is available in 5 UHF frequency ranges with up to 3,000 transmission frequencies per frequency range:

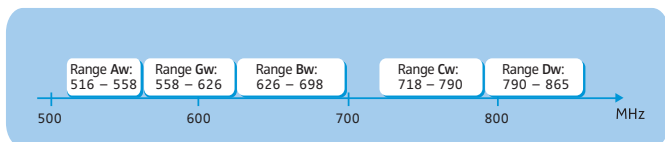

Each frequency range (Aw-Dw, Gw) offers 26 frequency banks with up to 64 channels each:

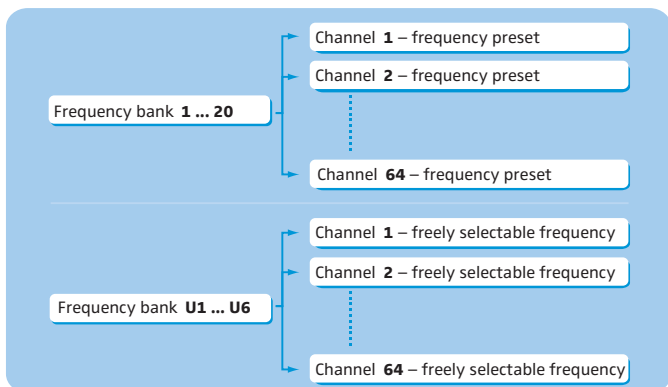

Each of the channels in the frequency banks “1” to “20” has been factory-preset to a fixed frequency (frequency preset). The factory-preset frequencies within one frequency bank are intermodulation-free. These frequencies cannot be changed.

For an overview of the frequency presets, please refer to the supplied frequency information sheet. Updated versions of the frequency information sheet can be downloaded from the SKP 2000 product page on our website at [www.sennheiser.com](http://www.sennheiser.com).

The frequency banks “U1” to “U6” allow you to freely select and store frequencies. It might be that these frequencies are **not** intermodulation-free.

## Delivery includes

The packaging contains the following items:

- 1 SKP 2000 plug-on transmitter
- 2 AA size batteries, 1.5 V
- 1 instruction manual
- 1 POP 1 pouch (with belt clip)
- 1 frequency information sheet
- 1 RF power information sheet

## Product overview

### Overview of the SKP 2000 plug-on transmitter

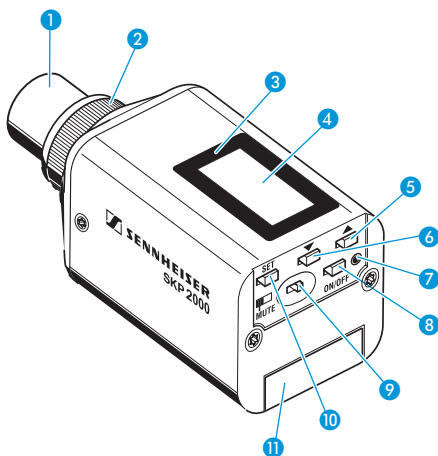



- 1 Microphone input, XLR-3 socket (female, unbalanced)
- 2 Mechanical locking ring of XLR-3 socket
- 3 Infra-red interface
- 4 Display panel, backlit in orange
- 5 UP button (▲)
- 6 DOWN button (▼)
- 7 Operation and battery status indicator, red LED  
lit = ON  
flashing = LOW BATTERY
- 8 ON/OFF button with ESC function (cancel)
- 9 MUTE switch
- 10 SET button
- 11 Battery compartment cover

## Overview of the displays

After switch-on, the plug-on transmitter displays the “Frequency/Name” standard display. For further illustrations and examples of the different standard displays, refer to page 14.

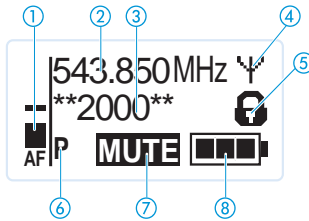
The display backlighting is automatically reduced after approx. 20 seconds.

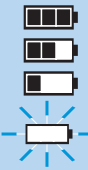

Display	Meaning
① Audio level “AF”	Modulation of the plug-on transmitter with peak hold function
② Frequency	Current transmission frequency
③ Name	Freely selectable name of the transmitter
④ Transmission icon	RF signal is being transmitted
⑤ Lock mode icon	Lock mode is activated
⑥ “P” (pilot tone)	Pilot tone transmission is activated
⑦ “MUTE”	Microphone input is muted
⑧ Battery status	Charge status:  approx. 100 % approx. 70 % approx. 30 % charge status is critical, the red <b>LOW BATTERY</b> LED ⑦ is flashing: 



## Putting the plug-on transmitter into operation

### Inserting the batteries/accupack

For powering the plug-on transmitter, you can either use two 1.5 V AA size batteries or the rechargeable Sennheiser BA 2015 accupack (see "Accessories" on page 30).

- ▶ Slide the battery compartment cover 11 in the direction of the embossed arrow and open the cover 11.

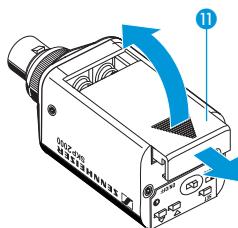

- ▶ Insert the two batteries or the accupack as shown below. Please observe correct polarity when inserting the batteries/accupack.

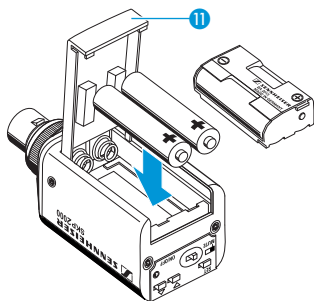

- ▶ Close the battery compartment.  
The battery compartment cover 11 locks into place with an audible click.

## Charging the accupack

- ▶ Remove the BA 2015 accupack.
- ▶ Insert the BA 2015 accupack into the L 2015 charger (see "Accessories" on page 30).



The L 2015 charger can only charge the BA 2015 accupack. Standard batteries (primary cells) or individual rechargeable battery cells cannot be charged.

## Plugging the plug-on transmitter onto a microphone

- ▶ Plug the microphone's XLR-3M socket onto the transmitter's XLR-3F socket ①. Make sure that the latch ⑫ locks into place.

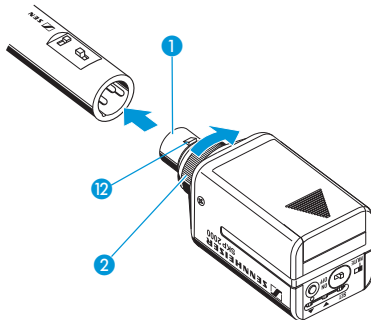

- ▶ Tighten the locking ring ② in the direction of the arrow.



The transmitter uses the microphone body as an antenna – therefore microphones with a metal casing should be used for best signal transmission.

## Using the plug-on transmitter

To establish a transmission link, proceed as follows:

1. Switch the receiver on (see the instruction manual of the receiver).
2. Switch the plug-on transmitter on (see next section).  
The transmission link is established and the diversity receiver's RF level display "RF" reacts.



It is vital to observe the notes on frequency selection on page 26.

If you cannot establish a transmission link between plug-on transmitter and receiver, read the chapter "Synchronizing the plug-on transmitter with a receiver" on page 26.

## Switching the plug-on transmitter on/off

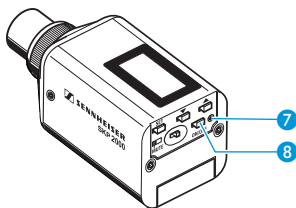

To switch the plug-on transmitter **on** (online operation):

- ON/OFF**  ▶ Press the **ON/OFF** button **8**.  
The plug-on transmitter transmits an RF signal. The red **ON LED 7** lights up and the "Frequency/Name" standard display appears on the display panel. The transmission icon **4** is displayed.

To switch the plug-on transmitter on and to **deactivate the RF signal on switch-on** (offline operation):

- ON/OFF**  ▶ Keep the **ON/OFF** button **8** pressed until "RF Mute On?" appears on the display panel.



- ▶ Press the **SET** button.

The transmission frequency is displayed but the plug-on transmitter does not transmit an RF signal. The transmission icon ④ is not displayed.



Use this function to save battery power or to prepare a plug-on transmitter for use during live operation without causing interference to existing transmission links.

To **activate** the **RF signal**:



- ▶ Press the **ON/OFF** button.

“RF Mute Off?” appears on the display panel.



- ▶ Press the **SET** button.

The transmission icon ④ is displayed again.

To switch the plug-on transmitter **off**:

- ▶ If necessary, deactivate the lock mode (see page 11).



- ▶ Keep the **ON/OFF** button ⑧ pressed until “OFF” appears on the display panel.

The red **ON LED** ⑦ goes off and the display panel turns off.



When in the operating menu, pressing the **ON/OFF** button ⑧ will cancel your entry (ESC function) and return you to the current standard display.

## Deactivating the lock mode temporarily

You can activate or deactivate the automatic lock mode via the “**Auto Lock**” menu item (see page 21). If the lock mode is activated, you have to temporarily deactivate it in order to be able to operate the plug-on transmitter:



- ▶ Press the **SET** button or the **ON/OFF** button.

“**Locked**” appears on the display panel.



- ▶ Press the **UP** button.

“**Unlock?**” appears on the display panel.



- ▶ Press the **SET** button.  
The lock mode is temporarily deactivated.

- When you are in the operating menu, the lock mode remains deactivated until you exit the operating menu.
- When one of the standard displays is shown, the lock mode is automatically activated after 10 seconds.

The lock mode icon ⑤ flashes prior to the lock mode being activated again.

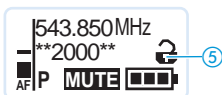

## Muting the audio signal or deactivating the RF signal

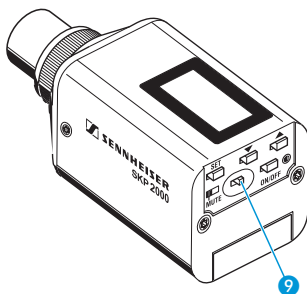

The **MUTE** switch ⑨ allows you to mute the audio signal or to deactivate the RF signal. Via the “**Mute Mode**” menu item, you can set the desired function of the **MUTE** switch ⑨ (see page 23).

Setting	Slide the MUTE switch ⑨...	Function
“AF On/Off”	... to the left (position <b>MUTE</b> )	Mutes the audio signal
	... to the right	Unmutes the audio signal
“RF On/Off”	... to the left (position <b>MUTE</b> )	Deactivates the RF signal (offline operation)
	... to the right	Activates the RF signal (online operation)
“Disabled”	No function	

- ▶ From the “**Mute Mode**” menu item, select the desired setting (see page 23).

- ▶ Exit the operating menu.
- ▶ Slide the **MUTE** switch ⑨ to the left, to the position **MUTE**.  
The plug-on transmitter reacts as indicated in the table.

The current state of the muting function or the RF signal is displayed on the display panel of the plug-on transmitter:

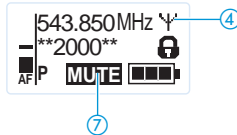

State	Transmitter's display panel
Audio signal is muted	"MUTE" ⑦ is displayed
Audio signal is activated (muting is canceled)	"MUTE" ⑦ is not displayed
RF signal is deactivated	"MUTE" ⑦ is displayed, transmission icon ④ is not displayed
RF signal is activated	"MUTE" ⑦ is not displayed, transmission icon ④ is displayed





You can also deactivate the RF signal on switch-on. For more information, refer to the chapter "Switching the plug-on transmitter on/off" on page 10.

Using the **ON/OFF** button, you can also activate/deactivate the RF signal during operation. To do so, briefly press the **ON/OFF** button and proceed as described on page 10.

## Selecting a standard display



▼ ▲ ▶ Press the UP/DOWN button to select a standard display:

Contents of the display	Selectable standard display
	"Frequency/Name"
	"Channel/Frequency"
	"Name/Channel"

## Using the operating menu

A special feature of the Sennheiser 2000 series is the consistent, intuitive menu structure of transmitters and receivers. As a result, adjustments to the settings can be made quickly – even in stressful situations, for example on stage or during a live show or presentation.

### The buttons

Button	Function of the button
Press the <b>ON/OFF</b> button 	<ul style="list-style-type: none"> <li>• Switches the plug-on transmitter on and off</li> <li>• Cancels the entry and returns to the current standard display (ESC function)</li> <li>• Activates/deactivates the RF signal</li> </ul>
Press the <b>SET</b> button 	<ul style="list-style-type: none"> <li>• Changes from the current standard display to the operating menu</li> <li>• Calls up a menu item</li> <li>• Enters a submenu</li> <li>• Stores the settings and returns to the operating menu</li> </ul>
Press the <b>UP/DOWN</b> button 	<ul style="list-style-type: none"> <li>• Selects a standard display</li> <li>• Changes to the next/previous menu item</li> <li>• Changes the setting of a menu item</li> </ul>

### Overview of the operating menu

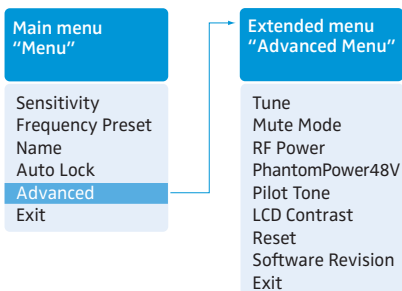



Display	Function of the menu item	Page
---------	---------------------------	------

### Main menu "Menu"

Sensitivity	Adjusts the sensitivity "AF"	19
Frequency Preset	Sets the frequency bank and the channel	20
Name	Enters a freely selectable name	21
Auto Lock	Activates/deactivates the automatic lock mode	21
Advanced	Calls up the extended menu "Advanced Menu"	22
Exit	Exits the operating menu and returns to the current standard display	–

### Extended menu "Advanced Menu"

Tune	Sets the transmission frequencies for the frequency banks "U1" to "U6"	22
	Sets the frequency bank, the channel and the transmission frequency (frequency banks "U1" to "U6")	23
Mute Mode	Sets the mode for the MUTE switch 9	23
RF Power	Adjusts the transmission power	24
PhantomPower 48V	Activates/deactivates the phantom powering	24
Pilot Tone	Activates/deactivates the pilot tone transmission	25
LCD Contrast	Adjusts the contrast of the display panel	25
Reset	Resets the settings made in the operating menu	25
Software Revision	Displays the current software revision	25
Exit	Exits the extended menu "Advanced Menu" and returns to the main menu	–

## Working with the operating menu



If the lock mode is activated, you have to deactivate it in order to be able to work with the operating menu (see page 11).

By way of example of the “Sensitivity” menu, this section describes how to use the operating menu.

### Changing from a standard display to the operating menu



- ▶ Press the SET button.

The current standard display is replaced by the main menu.  
The last selected menu item is displayed.

### Selecting a menu item



- ▶ Press the UP/DOWN button to change to the “Sensitivity” menu item.

The current setting of the menu item is displayed:

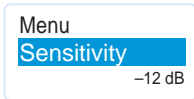

### Changing and storing settings

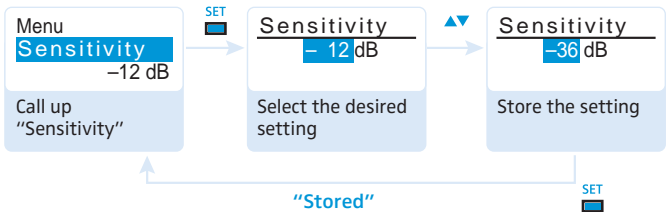

- ▶ Press the SET button to call up the menu item.



- ▶ Press the UP/DOWN button to adjust the input sensitivity.



- ▶ Press the SET button to store the setting.

### Canceling an entry

-  ▶ Press the **ON/OFF** button to cancel the entry.  
The current standard display appears on the display panel.

To subsequently return to the last edited menu item:

-  ▶ Press the **SET** button repeatedly until the last edited menu item appears.

### Exiting a menu item

-  ▶ Change to the “Exit” menu item.



-  ▶ Confirm your selection.  
You return to the next higher menu level or you exit the operating menu and return to the current standard display.

To directly return to the current standard display:

-  ▶ Press the **ON/OFF** button.

## Adjusting settings via the operating menu



Make use of the possibility to adjust settings via the operating menu of your receiver and to transfer these settings to the plug-on transmitter.



For more information, refer to the instruction manual of the receiver. The relevant information is marked with the sync icon.

### The main menu "Menu"

#### Adjusting the input sensitivity – "Sensitivity"

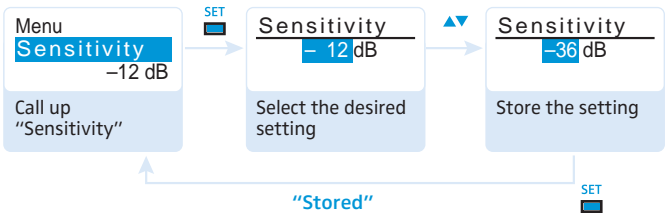

Adjustment range: 0 to -48 dB, adjustable in steps of 6 dB



The audio level display "AF" ① always indicates the audio level, even if the plug-on transmitter is muted, e.g. allowing you to check the adjusted sensitivity before live operation.



Input sensitivity adjusted...	Effect/display
... too high	<p>Close talking distances, speakers with loud voices or loud music passages cause overmodulation in the transmission link.</p> <p>The audio level display "AF" ① shows full deflection for the duration of the overmodulation.</p>

Input sensitivity adjusted...	Effect/display
... correctly	The audio level display "AF" ① shows full deflection only during the loudest passages.
... too low	The transmission link is undermodulated. This results in a signal with high background noise.



Adjust a low input sensitivity when using condenser microphones, adjust a high input sensitivity when using dynamic microphones.

### Selecting the frequency bank and the channel manually – "Frequency Preset"

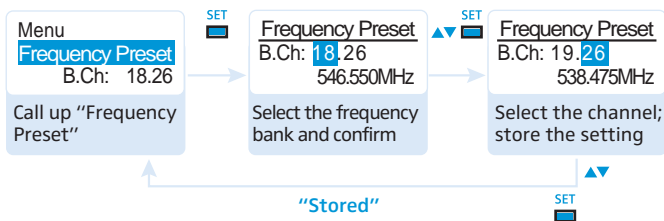

When you are in the "Frequency Preset" menu item, the RF signal is deactivated.

Overview of the frequency banks and channels:

Frequency bank	Channels	Type
"1" to "20"	up to 64 per frequency bank	System bank: frequencies are factory-preset
"U1" to "U6"	up to 64 per frequency bank	User bank: frequencies are freely selectable



When setting up multi-channel systems, please observe the following:

Only the factory-preset frequencies within one frequency bank ("1" to "20") are intermodulation-free. It is vital to observe the notes on frequency selection on page 26.

## Entering a name – “Name”

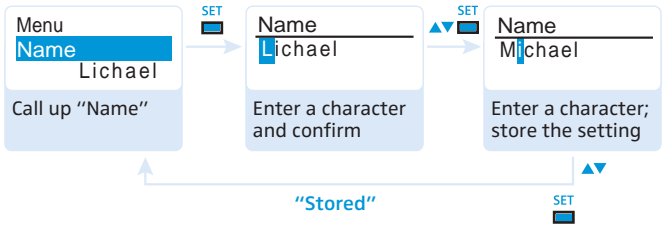

Via the “Name” menu item, you can enter a freely selectable name (e.g. the name of the performer) for the plug-on transmitter. The name can be displayed on the “Frequency/Name” and “Name/Channel” standard displays (see page 14). The name can consist of up to 8 characters such as:

- letters (without pronunciation marks),
- numbers from 0 to 9,
- special characters and spaces.

To enter a name, proceed as follows:

- ▼ ▲ ► Press the UP/DOWN button to select a character.
- SET** ► Press the **SET** button to change to the next segment/character or to store the complete entry.

## Activating/deactivating the automatic lock mode – “Auto Lock”

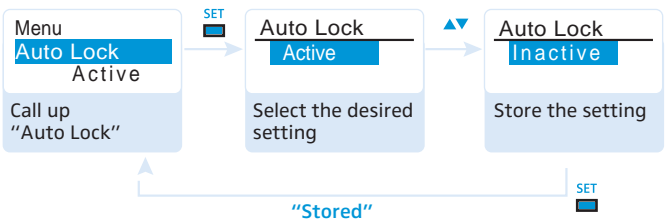

The lock mode prevents that the plug-on transmitter is accidentally switched off or programmed during operation. The lock mode icon ⑤  on the current standard display indicates that the lock mode is activated.

- ▼ ▲ ► Press the UP/DOWN button to select the desired setting.

For information on how to use the lock mode, refer to page 11.

## The extended menu “Advanced Menu”

### Setting the transmission frequencies for the frequency banks “U1” to “U6” – “Tune”



When you have selected one of the system banks and then select the “Tune” menu, the plug-on transmitter automatically switches to channel 1 of the frequency bank “U1”. In this case, “U1.1” briefly appears on the display panel.

Upon delivery, the channels of the frequency banks “U1” to “U6” are not assigned a transmission frequency.

When you are in the “Tune” menu item, the RF signal is deactivated.

Via the “Tune” menu item, you can:

1. set a transmission frequency to be stored in the current channel of the frequency bank (“U1” to “U6”)
2. or select a frequency bank (“U1” to “U6”) and a channel and assign this channel a transmission frequency.



It is vital to observe the notes on frequency selection on page 26.

### Setting a transmission frequency for the current channel

- ▼ ▲ ▶ Press the UP/DOWN button until the “Tune” menu item appears.



- ▶ Press the SET button.  
The frequency selection appears.

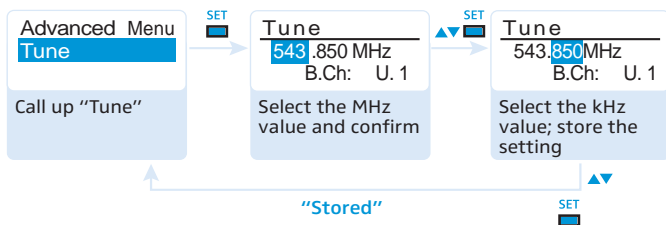

- ▶ Set the desired frequency.



- ▶ Press the SET button.  
Your settings are stored. The “Tune” menu item appears.

## Selecting a frequency bank and a channel and assigning this channel a transmission frequency

- ▶ Press the UP/DOWN button until the “Tune” menu item appears.



- ▶ Keep the SET button pressed until the frequency bank selection appears.

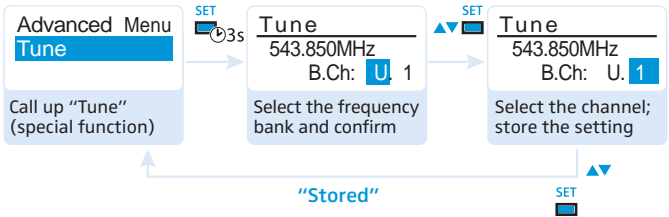

- ▶ Set the desired frequency bank and the desired channel.



- ▶ Press the SET button.  
The frequency selection appears.

- ▶ Set the desired frequency.

## Setting the mode for the MUTE switch – “Mute Mode”

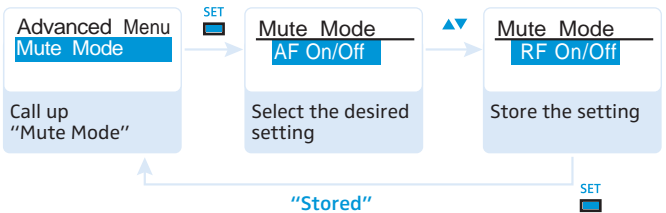

Mode	Function
“AF On/Off”	When the switch is in the MUTE position, no audio signal is transmitted.
“RF On/Off”	When the switch is in the MUTE position, the RF signal is deactivated.
“Disabled”	The muting function is deactivated.

For information on how to use the MUTE switch 9, refer to page 12.



## Adjusting the transmission power – “RF Power”

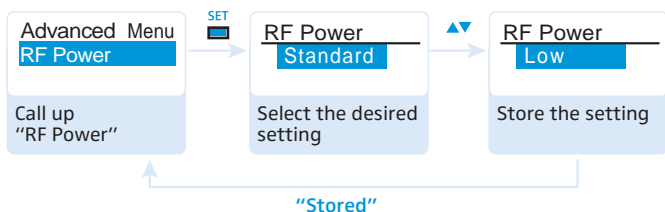

Via the “RF Power” menu item, you can adjust the transmission power in three steps (“Low”, “Standard” and “High”).



It is vital to observe the notes on the enclosed frequency information sheet!

## Activating/deactivating the phantom powering – “PhantomPower 48V”

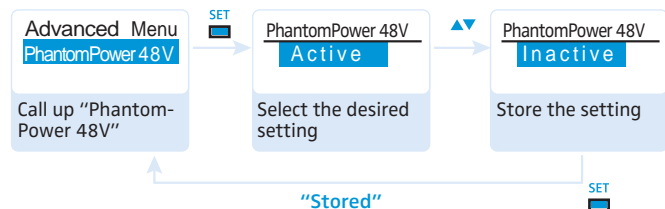

Via the “PhantomPower 48V” menu item, you can activate or deactivate the 48V phantom powering for condenser microphones.

## Activating/deactivating the pilot tone transmission – “Pilot Tone”

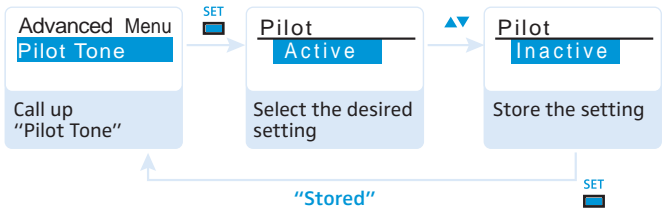

The plug-on transmitter adds an inaudible pilot tone to the audio signal. The receiver detects and evaluates the pilot tone, and is thus able to identify the signal of the matching transmitter and mute all others. The pilot tone supports the receiver's squelch function.

## Adjusting the contrast of the display panel – “LCD Contrast”

You can adjust the contrast of the display panel in 16 steps.

## Resetting the settings made in the operating menu – “Reset”

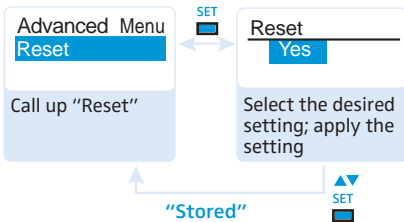

When resetting the settings made in the operating menu, only the selected settings for the pilot tone and for the frequency banks “U1” to “U6” remain unchanged. For an overview of the factory-preset default settings, refer to the enclosed frequency information sheet.

## Displaying the software revision – “Software Revision”

You can display the current software revision of the plug-on transmitter.

- For information on software updates, visit the SKP 2000 product page at [www.sennheiser.com](http://www.sennheiser.com).

## Synchronizing the plug-on transmitter with a receiver

When synchronizing the plug-on transmitter with a receiver, please observe the following:



- ▶ Only use a plug-on transmitter and a receiver from the same frequency range (see the type plates on the transmitter and the receiver).
  - ▶ Make sure that the desired frequencies are listed in the enclosed frequency information sheet.
  - ▶ Make sure that the desired frequencies are approved and legal in your country and, if necessary, apply for an operating license.
- 

### Synchronizing the plug-on transmitter with the receiver – individual operation

Upon delivery, the plug-on transmitter and the receiver are synchronized with each other. If, however, you cannot establish a transmission link between plug-on transmitter and receiver, you have to synchronize the channels of the devices.

For information on automatic synchronization of the plug-on transmitter with the receiver (individual operation), refer to the instruction manual of the receiver. This information is marked with the  icon.

Alternatively, you can set the channel on the plug-on transmitter manually:

- ▶ Make sure that you set the plug-on transmitter to the same frequency bank and the same channel as the receiver (see page 20).

If you still cannot establish a transmission link, refer to the chapter “If a problem occurs ...” on page 29.

## Synchronizing plug-on transmitters with receivers – multi-channel operation

Combined with 2000 series receivers, 2000 series plug-on transmitters can form transmission links that can be used in multi-channel systems.

For information on automatic synchronization of plug-on transmitters with receivers (multi-channel operation), refer to the instruction manual of your receiver.

For more information on multi-channel operation, visit the SKP 2000 product page at [www.sennheiser.com](http://www.sennheiser.com).

## Cleaning the plug-on transmitter

---

**CAUTION!** Liquids can damage the electronics of the plug-on transmitter!

Liquids entering the housing of the device can cause a short-circuit and damage the electronics.

- ▶ Keep all liquids away from the plug-on transmitter.
- ▶ Do not use any solvents or cleansing agents.

- 
- ▶ Use a cloth to clean the plug-on transmitter from time to time.

## Recommendations and tips

### ... for the plug-on transmitter

- For best results, make sure that the transmitter sensitivity is correctly adjusted.

### ... for optimum reception

- Transmission range depends to a large extent on location and can vary from about 10 m to about 150 m. There should be a “free line of sight” between plug-on transmitter and receiving antennas.
- To avoid overloading the receiver, observe a minimum distance of 5 m between plug-on transmitter and receiving antennas.
- The plug-on transmitter uses the microphone body as an antenna – therefore microphones with a metal casing should be used for best signal transmission.

### ... for multi-channel operation

- When operating a multi-channel system, you should only use the channels within one frequency bank. Each of the frequency banks “1” to “20” accommodates factory-preset frequencies which are intermodulation-free.
- When using several transmitters simultaneously, interference can be avoided by maintaining a minimum distance of 20 cm between two transmitters.

## If a problem occurs ...

Problem	Possible cause	Possible solution
Plug-on transmitter cannot be operated, "Locked" appears on the display panel	Lock mode is activated	Deactivate the lock mode (see page 11).
No operation indication	Batteries are flat or accupack is flat	Replace the batteries or recharge the accupack (see page 9).
No RF signal at the receiver	Plug-on transmitter and receiver are not on the same channel	Set the plug-on transmitter to the same channel as the receiver. Synchronize the plug-on transmitter with the receiver (see page 26).
	Transmission range is exceeded	Reduce the distance between plug-on transmitter and receiving antennas.
	RF signal is deactivated ("RF Mute")	Activate the RF signal (see page 12).
RF signal available, no audio signal, "MUTE" appears on the display panel	Plug-on transmitter is muted (MUTE)	Cancel the muting (see page 12).
	Receiver's squelch threshold is adjusted too high	Reduce the squelch threshold setting on the receiver.
	Plug-on transmitter doesn't transmit a pilot tone	Activate the pilot tone transmission on the transmitter (see page 25).
Audio signal has a high level of background noise or is distorted	Plug-on transmitter's sensitivity is adjusted too low/ too high	Adjust the input sensitivity (see page 19).

If a problem occurs that is not listed in the above table or if the problem cannot be solved with the proposed solutions, please contact your local Sennheiser partner for assistance. To find a Sennheiser partner in your country, search at [www.sennheiser.com](http://www.sennheiser.com) under "Service & Support".

## Accessories

The following SKP 2000 accessories are available from your specialist dealer:

Cat. No.	Accessory
009950	BA 2015 accupack
009828	L 2015 charger
005232	POP 1 pouch (with belt clip)

# Specifications

## RF characteristics

Modulation	wideband FM
Frequency ranges	516–558, 558–626, 626–698, 718–790, 790–865 MHz (Aw to Dw, Gw, see page 4)
Transmission frequencies	up to 3,000 frequencies, tuneable in steps of 25 kHz  20 frequency banks, each with up to 64 factory-preset channels  6 frequency banks, each with up to 64 user programmable channels
Switching bandwidth	up to 75 MHz
Nominal/peak deviation	$\pm 24$ kHz/ $\pm 48$ kHz
Frequency stability	$\leq \pm 15$ ppm
RF output power at 50 $\Omega$	switchable: typ. 10 mW (“Low”) typ. 30 mW (“Standard”) typ. 50 mW (“High”)
Pilot tone squelch	can be switched off

## AF characteristics

Compander system	Sennheiser HDX
AF frequency response	80–18,000 Hz
Signal-to-noise ratio (1 mV, peak deviation)	$\geq 120$ dBA
THD	$\leq 0.9$ %
Max. input voltage	6 V <sub>rms</sub>
Input impedance	6 k $\Omega$ , balanced
Adjustment range of input sensitivity	48 dB, adjustable in steps of 6 dB



## Specifications

### Overall device

Temperature range	- 10 °C to + 55 °C
Power supply	2 AA size batteries, 1.5 V or BA 2015 accupack
Nominal voltage	2.4 V $\text{---}$
Power consumption:	
• at nominal voltage	typ. 210 mA (30 mW RF, w/o P48)
• with switched-off plug-on transmitter	$\leq$ 25 $\mu$ A
Operating time	typ. 7 hrs (30 mW RF, w/o P48)
Dimensions	approx. 105 mm x 43 mm x 43 mm
Weight (incl. batteries)	approx. 195 g

### In compliance with

Europe:	EMC	EN 301489-1/-9
	Radio	EN 300422-1/-2
	Safety	EN 60065 EN 62311 (SAR)

### Approved by

Canada:	Industry Canada RSS 123 IC: 2099A-SKP2000 limited to 806 MHz
USA:	FCC-Part 74 FCC-ID: DMOSKP2000 limited to 698 MHz

### Pin assignment of the XLR-3 socket

#### XLR-3 socket (female), balanced (Audio In)

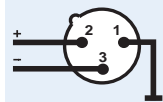

# Manufacturer Declarations

## Warranty

Sennheiser electronic GmbH & Co. KG gives a warranty of 24 months on this product.

For the current warranty conditions, please visit our web site at [www.sennheiser.com](http://www.sennheiser.com) or contact your Sennheiser partner.

## In compliance with the following requirements

- RoHS Directive (2002/95/EC)
- WEEE Directive (2002/96/EC)



Please dispose of the plug-on transmitter at the end of its operational lifetime by taking it to your local collection point or recycling center for such equipment.

- Battery Directive (2006/66/EC)



The supplied batteries or rechargeable batteries can be recycled. Please dispose of them as special waste or return them to your specialist dealer. In order to protect the environment, only dispose of exhausted batteries.

## CE Declaration of Conformity

- CE0682 ⓘ
- R&TTE Directive (1999/5/EC)

The declarations are available at [www.sennheiser.com](http://www.sennheiser.com).

Before putting the device into operation, please observe the respective country-specific regulations.

## Statements regarding FCC and Industry Canada

This device complies with Part 15 of the FCC Rules and with RSS-210 of Industry Canada. Operation is subject to the following two conditions: (1) this device may not cause harmful interference, and (2) this device must accept any interference received, including interference that may cause undesired operation.

This equipment has been tested and found to comply with the limits for a Class B digital device, pursuant to Part 15 of the FCC Rules. These limits are designed to provide reasonable protection against harmful interference in a residential installation. This equipment generates, uses and can radiate radio frequency energy and, if not installed and used in accordance with

the instructions, may cause harmful interference to radio communications. However, there is no guarantee that interference will not occur in a particular installation. If this equipment does cause harmful interference to radio or television reception, which can be determined by turning the equipment off and on, the user is encouraged to try to correct the interference by one or more of the following measures:

- Reorient or relocate the receiving antenna.
- Increase the separation between the equipment and receiver.
- Connect the equipment into an outlet on a circuit different from that to which the receiver is connected.
- Consult the dealer or an experienced radio/TV technician for help.

This class B digital device complies with the Canadian ICES-003.

Changes or modifications made to this equipment not expressly approved by Sennheiser electronic Corp. may void the FCC authorization to operate this equipment.

Before putting the device into operation, please observe the respective country-specific regulations!

# Index

## accupack

- charging 9
- inserting 8

## activating/deactivating

- lock mode (Auto Lock) 21
- phantom powering (PhantomPower 48V) 24
- pilot tone transmission (Pilot Tone) 25

## adjusting

- contrast (LCD Contrast) 25
- input sensitivity (Sensitivity) 19
- transmission power (RF Power) 24

## Advanced Menu (extended menu)

- overview 16
- settings 22

## AF (audio level) 7

## AF PEAK (overmodulation) 7

## audio signal, muting (Mute) 12

## Auto Lock (activating/deactivating the lock mode) 21

## batteries, inserting 8

## buttons (function of the ~) 15

## channel

- assigning a frequency 23
- overview 4
- selecting (Frequency Preset) 20
- selecting (Tune) 22

## charging

- accupack 9
- battery status display 7

## cleaning (plug-on transmitter) 27

## connecting (microphones) 9

## deactivating temporarily (lock mode) 11

## displays

- adjusting the contrast of the display panel (LCD Contrast) 25
- charge status 7
- overview 7
- standard displays 14

## factory default settings (resetting the settings in the operating menu) 25

## frequency

- ~ ranges 4
- preset frequencies 4
- selecting ~ presets 20
- setting a transmission frequency 22

## frequency bank

- ~ system 4
- overview 4
- selecting (Frequency Preset) 20

## Frequency Preset (selecting a frequency bank/channel) 20

## infra-red transmission 26

## inserting (batteries/accupack) 8

## LCD Contrast (adjusting the contrast of the display panel) 25

## lock mode

- activating/deactivating (Auto Lock) 21
- deactivating temporarily 11

- Locked (lock mode activated)** 11
- Menu (main menu)**
  - overview 15
  - settings 19
- microphones**
  - connecting 9
  - overview 3
  - suitable ~ 3
- multi-channel operation** 27
- Mute (muting the audio signal)** 12
- Mute Mode (setting the mode for the MUTE switch)** 23
- MUTE switch**
  - function 12
  - setting the mode (Mute Mode) 23
- muting (audio signal)** 12
- Name (entering a name)** 21
- offline operation (RF signal deactivated)** 10
- online operation (RF signal activated)** 10
- PhantomPower P48V (activating/deactivating the phantom powering)** 24
- pilot tone**
  - activating/deactivating transmission 25
- plug-on transmitter**
  - cleaning 27
  - switching on/off 10
  - synchronizing with receiver 26
- Reset (resetting the settings in the operating menu)** 25
- RF Mute On/Off (activating/deactivating the RF signal)** 10
- RF Power (adjusting the transmission power)** 24
- RF signal**
  - activating 11
  - activating (online operation) 10
  - deactivating (during operation) 13
  - deactivating (offline operation) 10, 12
- Sensitivity (adjusting the input sensitivity)** 19
- setting up (transmission link)** 26
- Software Revision (displaying the software revision)** 25
- switching on/off (plug-on transmitter)** 10
- synchronizing (plug-on transmitter/receiver)** 26
- transmission frequency**
  - selecting (Frequency Preset) 20, 22
  - setting (Tune) 22
- transmission power, optimizing** 28
- troubleshooting** 29
- Tune (setting the transmission frequencies and frequency banks)** 22
- Unlock (deactivating the lock mode)** 11
- using**
  - operating menu 17
  - plug-on transmitter 10

Sennheiser electronic GmbH & Co. KG  
Am Labor 1, 30900 Wedemark, Germany  
[www.sennheiser.com](http://www.sennheiser.com)

Printed in Germany  
Publ. 06/09  
529676/A01